



# GLIDESCOPE SYSTEM RANGER SINGLE USE

Operations & Maintenance Manual



# GLIDESCOPE SYSTEM RANGER SINGLE USE

## Operations & Maintenance Manual

Effective: April 1, 2016

Caution: Federal (United States) law restricts this device to sale by or on the order of a physician.

## CONTACT INFORMATION

To obtain additional information regarding your GlideScope system, please contact Verathon® Customer Care or visit [verathon.com/support](http://verathon.com/support).

### Verathon Inc.

20001 North Creek Parkway  
Bothell, WA 98011 U.S.A.  
800.331.2313 (US and Canada only)  
Tel: 425.867.1348  
Fax: 425.883.2896  
[verathon.com](http://verathon.com)



### Verathon Medical (Europe) B.V.

Willem Fenengastraat 13  
1096 BL Amsterdam  
The Netherlands  
Tel: +31 (0) 20 210 30 91  
Fax : +31 (0) 20 210 30 92



### Verathon Medical (Canada) ULC

2227 Douglas Road  
Burnaby, BC V5C 5A9  
Canada  
Tel: 604.439.3009  
Fax: 604.439.3039

**CE 0413**

Copyright © 2009, 2016 by Verathon Inc. All rights reserved.

GlideScope, the GlideScope symbol, GlideRite, GVL, Verathon, and the Verathon Torch symbol are trademarks of Verathon Inc. All other brand and product names are trademarks or registered trademarks of their respective owners.

Information in this manual may change at any time without notice. For the most up-to-date information, see the documentation available at [verathon.com/product-documentation](http://verathon.com/product-documentation).

# TABLE OF CONTENTS

---

- IMPORTANT INFORMATION..... 1**
  - Product Description ..... 1
  - Statement of Intended Use..... 1
  - Essential Performance ..... 1
  - Statement of Prescription ..... 1
  - Notice to All Users ..... 1
  - Precautions & Warnings ..... 2
  
- INTRODUCTION ..... 7**
  - Single-Use System..... 7
  - System Parts & Accessories ..... 8
  - Monitor Controls & Connections ..... 9
  - Video Laryngoscope Components..... 9
  
- SETTING UP ..... 10**
  - Procedure 1. Perform Initial Inspection ..... 10*
  - Procedure 2. Charge the Monitor ..... 11*
  - Procedure 3. Connect a Video Baton ..... 13*
  - Procedure 4. Perform a Functional Check ..... 14*
  
- USING THE DEVICE ..... 15**
  - Procedure 1. Connect a Video Baton ..... 16*
  - Procedure 2. Insert the Video Baton into the Stat..... 17*
  - Procedure 3. Prepare the System ..... 18*
  - Procedure 4. Intubate Using the GlideScope 4-Step Technique..... 19*

**CLEANING & DISINFECTING .....20**

- General Information.....20
  - Procedure 1. Clean the Video Monitor.....22*
  - Procedure 2. Clean the Video Baton Cradle .....22*
  - Procedure 3. Clean the Storage Case.....22*
- Video Baton.....23
  - Procedure 1. Remove the Stat .....23*
  - Procedure 2. Clean & Disinfect the Video Baton .....24*
  - Procedure 3. Inspect the Video Baton.....26*

**MAINTENANCE & SAFETY .....27**

- Periodic Inspections .....27
- System Software .....27
- GlideScope Ranger Battery.....27
- Device Repair .....28
- Device Disposal.....28

**WARRANTY.....29**

**PRODUCT SPECIFICATIONS.....31**

- System Specifications .....31
- Component Specifications .....32
- Electromagnetic Compatibility.....37

**SYMBOL DIRECTORY .....41**

**GLOSSARY .....43**

# IMPORTANT INFORMATION

---

## PRODUCT DESCRIPTION

GlideScope Ranger is a portable, compact video laryngoscope that provides a clear, real-time view of a patient's airway, enabling quick intubation. The Ranger system is designed for field (military and pre-hospital) use.

Designed for "1st Pass Success" in military and emergency settings, the Ranger system features rugged, high-impact construction, patented blade angulation, a patented anti-fogging mechanism, and a non-glare monitor that is easily visible in bright light. The device is dependable in an array of field conditions, making it ideal for pre-hospital and critical care situations. The GlideScope Ranger video laryngoscope has been granted Airworthiness Certification from the United States Army.

The Ranger is operational in seconds. It is compact for easy carrying and storage. The integrated, rechargeable lithium battery provides a minimum 90-minute continuous-use autonomy and allows for approximately 20 intubations per battery cycle (depending on usage).

## STATEMENT OF INTENDED USE

GlideScope Ranger video laryngoscopes are intended for use by qualified medical professionals to obtain a clear, unobstructed view of the vocal cords for medical procedures.

## ESSENTIAL PERFORMANCE

*Essential performance* is the system performance necessary to achieve freedom from unacceptable risk. The essential performance of the GlideScope Ranger system is to provide a clear view of the vocal cords.

## STATEMENT OF PRESCRIPTION

Caution: Federal (United States) law restricts this device to sale by or on the order of a physician.

This system should be used only by individuals who have been trained and authorized by a physician or used by healthcare providers who have been trained and authorized by the institution providing patient care.

## NOTICE TO ALL USERS

Verathon® recommends that all users read this manual before using the system. Failure to do so may result in injury to the patient, compromise the performance of the system, and may void the system warranty.

Verathon recommends that new GlideScope users:

- Obtain instruction from a qualified individual
- Practice using the system on a mannequin before clinical use
- Acquire clinical experience on patients without airway abnormalities

# PRECAUTIONS & WARNINGS

*Warnings* indicate that injury, death, or other serious adverse reactions may result from use or misuse of the device. *Cautions* indicate that use or misuse of the device may cause a problem, such as a malfunction, failure, or damage to the product. Throughout the manual, pay attention to sections labeled *Important*, as these contain reminders or summaries of the following cautions as they apply to a specific component or use situation. Please heed the following warnings and cautions.

## PRECAUTIONS



### CAUTION

Medical electrical equipment requires special precautions regarding electromagnetic compatibility (EMC) and must be installed and operated according to the instructions in this manual. For more information, see the [Electromagnetic Compatibility](#) section on page 37.

To maintain electromagnetic interference (EMI) within certified limits, the GlideScope Ranger system must be used with the cables, components, and accessories specified or supplied by Verathon®. For additional information, see the [System Parts & Accessories](#) and [Component Specifications](#) sections. The use of accessories or cables other than those specified or supplied may result in increased emissions or decreased immunity of the system.

The GlideScope system should not be used adjacent to or stacked with other equipment. If adjacent or stacked use is necessary, the system should be observed to verify normal operation in the configuration in which it will be used.

This device can radiate radio frequency energy and is very unlikely to cause harmful interference with other devices in the vicinity. There is no guarantee that interference will not occur in a particular installation. Evidence of interference may include degradation of performance in this device or other devices when operated simultaneously. If this occurs, try to correct the interference by using the following measures:

- Turn devices on and off in the vicinity to determine the source of interference
- Reorient or relocate this device or other devices
- Increase the separation between devices
- Connect the device to an outlet on a circuit different than the other device(s)
- Eliminate or reduce EMI with technical solutions (such as shielding)
- Purchase medical devices that comply with IEC 60601-1-2 EMC standards

Be aware that portable and mobile radio frequency communications equipment (cellular phones, etc.) may affect medical electrical equipment; take appropriate precautions during operation.





#### CAUTION

Bleach may be used on the video batons, but pay special attention to stainless steel components, as bleach can corrode stainless steel.



#### CAUTION

Ensure that you do not use any abrasive substances, brushes, pads, or tools when cleaning the video monitor screen. The screen can be scratched, permanently damaging the device.



#### CAUTION

**Risk of permanent equipment damage.** This product is sensitive to heat, which will cause damage to the electronics. Do not expose the system to temperatures above 60°C (140°F), and do not use autoclaves or pasteurizers. Use of such methods to clean, disinfect, or sterilize the components will cause permanent device damage and void the warranty. For a list of approved cleaning procedures and products, refer to the [Cleaning & Disinfecting](#) chapter.



#### CAUTION

The system contains electronics that could be damaged by ultrasonic and automated washing equipment. Do not use an ultrasonic device or automated washing equipment to clean this product.



#### CAUTION

The GlideScope Ranger video monitor is manufactured to be IP68 compliant. If the monitor is disassembled during a service procedure, after reassembly, the monitor will not be IP68 compliant.

## WARNINGS



### WARNING

Before every use, ensure the instrument is operating correctly and has no sign of damage. Do not use this product if the device appears damaged. Always ensure that alternative airway management methods and equipment are readily available.

Report any suspected defects to Verathon® Customer Care. For contact information, visit [verathon.com/support](http://verathon.com/support).



### WARNING

GlideScope systems are delivered nonsterile and require cleaning or disinfection prior to initial use.



### WARNING

Because the product may be contaminated with human blood or body fluids capable of transmitting pathogens, all cleaning facilities must be in compliance with (U.S.) OSHA Standard 29 CFR 1910.1030 "Bloodborne Pathogens" or an equivalent standard. For more information, visit [www.osha.gov](http://www.osha.gov).



### WARNING

Cleaning is critical to ensuring a component is ready for disinfection or sterilization. Failure to properly clean the device could result in a contaminated instrument after completing the disinfection or sterilization procedure.

When cleaning, ensure all foreign matter is removed from the surface of the device. This allows the active ingredients of the chosen disinfection method to reach all the surfaces.



### WARNING

This product may only be cleaned, disinfected, or sterilized by using the approved low-temperature processes provided in this manual. Cleaning, disinfection, and sterilization methods listed are recommended by Verathon based on efficacy or compatibility with component materials.



### WARNING

Do not place the video baton in the cradle if any of the components are contaminated.



#### WARNING

Availability of cleaning, disinfection, and sterilization products varies by country, and Verathon® is unable to test products in every market. For more information, please contact Verathon Customer Care. For contact information, visit [verathon.com/support](http://verathon.com/support).



#### WARNING

Ensure that you follow the manufacturer's instructions for handling or disposing of the cleaning, disinfection, or sterilization solutions provided in this manual.



#### WARNING

Do not reuse, reprocess or resterilize single-use components. Reuse, reprocessing or resterilization may create a risk of contamination of the device, cause patient infection or cross-infection.



#### WARNING

This instrument and related devices may contain batteries and other environmentally hazardous materials. When the instrument or accessories have reached the end of their useful service life, see the section [Device Disposal](#) on page 28. Dispose of used, single-use components as infectious waste.



#### WARNING

Several areas of the Stat that contact the patient can exceed 41°C (106°F) as part of normal operation:

- The first area is the light-emitting area surrounding the camera. When used as indicated, continuous contact with this area is unlikely because, if tissue were to contact this area, the view would be lost and devices would need to be adjusted to regain the airway view.
- The second area is the area surrounding the camera, out of view of the camera. Continuous contact with this area is unlikely because the product is typically not held stationary for an extended period of time exceeding 1 minute.

If continuous contact is maintained for longer than 1 minute, it is possible to cause thermal damage such as a burn to the mucosal tissue.



### WARNING

When you are guiding the endotracheal tube to the distal tip of the video laryngoscope, ensure that you are looking in the patient's mouth, not at the video monitor screen. Failure to do so may result in injury to the tonsils or soft palate.



### WARNING

In order to maintain electrical safety, use only the provided, medical-approved power supply.



### WARNING

To reduce the risk of electrical shock, use only the accessories and peripherals recommended by Verathon®.



### WARNING

No modification of this equipment is allowed.



### WARNING

**Electric shock hazard.** Do not attempt to open the system components. This may cause serious injury to the operator or damage to the instrument and will void the warranty. Contact Verathon Customer Care for all servicing needs.



### WARNING

When cleaning the power adapter, use a cloth dampened with isopropyl alcohol on the outside of the enclosure. Do not immerse the power adapter in water.



### WARNING

Do not use the power adapter in the presence of flammable anesthetics.



### WARNING

Do not reuse, reprocess, or resterilize single-use components. Reuse, reprocessing, or resterilization may create a risk of contamination of the device, causing patient infection or cross-infection.

# INTRODUCTION

---

## SINGLE-USE SYSTEM

The GlideScope Ranger system is available in a single-use configuration. It features a video monitor, a reusable video baton, the cables and adapters to power the device, and any optional system components that may facilitate intubations or provide convenience.

The laryngoscope is a reusable video baton that is inserted into a single-use, disposable Stat. The video baton connects to the video monitor and contains the camera and electronics that process the video data captured by the baton. Stats are available in a wide range of sizes, and each size corresponds to one of two video baton sizes.

*Figure 1. Ranger Single-Use System*



# SYSTEM PARTS & ACCESSORIES

Table 1. Required System Components









REQUIRED PARTS & ACCESSORIES					
Video monitor		Power supply		Power cable	
					
Video baton 1-2			Video baton 3-4		
					
GVL Stat 0	GVL Stat 1	GVL Stat 2	GVL Stat 2.5	GVL Stat 3	GVL Stat 4
					

Table 2. Optional System Components

OPTIONAL PARTS & ACCESSORIES		
GlideRite® Rigid Stylet	Ranger Transport Bag	Video Baton Cradle & Case
		

## MONITOR CONTROLS & CONNECTIONS

The digital, full-color video monitor displays the images transmitted from the camera in the video baton. The monitor includes the screen and controls you use to operate the system. It contains a lithium battery that provides power to the system. The system must be operated exclusively on battery power, without a connection to an AC power source.

Figure 2. Ranger Video Monitor

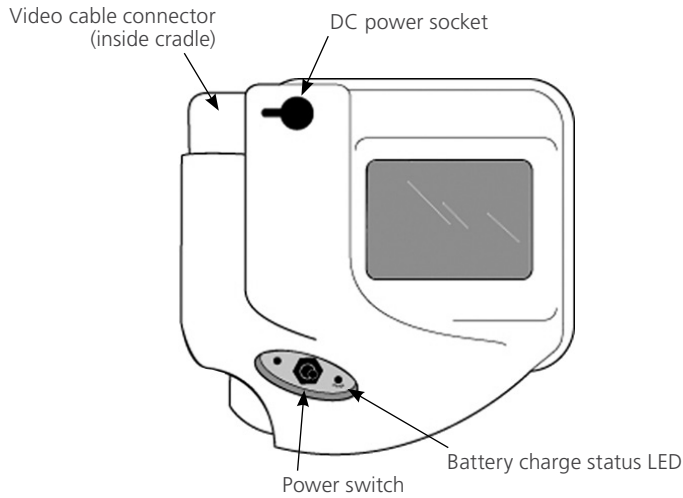

## VIDEO LARYNGOSCOPE COMPONENTS

Figure 3. Single-Use Video Laryngoscope Components



# SETTING UP

---

Before you can use the system for the first time, you must inspect the components, set up the system, and perform a functional test as recommended by Verathon®. Complete the following procedures:

- Procedure 1: Perform Initial Inspection
- Procedure 2: Charge the Monitor
- Procedure 3: Connect a Video Baton
- Procedure 4: Perform a Functional Check

---

## PROCEDURE 1. PERFORM INITIAL INSPECTION

---

When you receive the system, Verathon recommends that an operator familiar with the instrument perform a full visual inspection of the system for any obvious physical damage that may have occurred during shipment.

1. Verify that you have received the appropriate components for your system by referring to the packing list included with the system.
2. Inspect the components for damage.
3. If any of the components are missing or damaged, notify the carrier and Verathon Customer Care or your local representative. For contact information, visit [verathon.com/support](https://www.verathon.com/support).



## PROCEDURE 2. CHARGE THE MONITOR



### WARNING

In order to maintain electrical safety, use only the provided, medical-approved power supply.

The video monitor includes an internal lithium battery. You must charge the battery fully prior to first use. The system must be operated exclusively on battery power, without a connection to an AC power source.

Under normal operating conditions, a fully charged battery lasts approximately 90 minutes. For optimal battery life, ensure that the battery is fully charged before you use the monitor.

*Note: The system will not operate while charging. If you switch the instrument on during charging, the charging light flashes.*

Figure 4. Battery Charge Level Icons

- **Steady green**—The battery is fully charged.
- **Flashing green**—Battery power is low. The LED flashes for approximately 5 minutes before the system turns off.
- **No LED**—The battery is completely depleted and needs to be recharged.
- **Steady orange**—The monitor is connected to an AC power source and the battery is charging.
- **Flashing orange**—There is an issue with the battery.

If you observe the flashing orange light, ensure the monitor power switch is in the off position, check the cable connections, and then disconnect and reconnect the charging cable to the monitor. If this does not resolve the issue, contact Verathon® Customer Care.

1. Ensure that the power switch is in the OFF position.

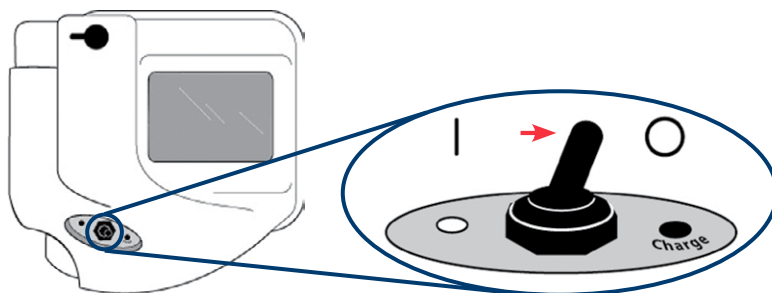

2. Connect the video monitor 12V DC power supply to the power cord.

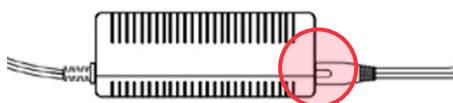

3. On the front of the monitor, unscrew the power socket cap, and then connect the charging cable to the power socket.

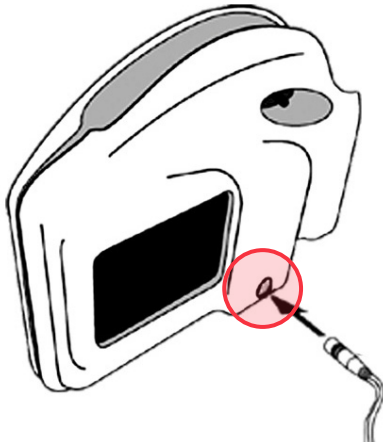

4. Plug the power cord into an AC power outlet.

*Note: Plug varies by region.*

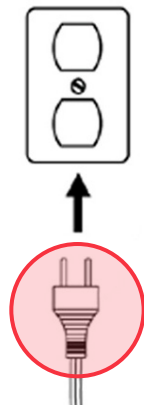

5. Allow the battery to charge. Fully charging the battery may take up to 5 hours.
  - While the battery is charging, the LED is orange.
  - When the battery has completed charging, the LED turns green.

---

## PROCEDURE 3. CONNECT A VIDEO BATON

---

The video baton attaches directly to the video monitor, supplying power to the video baton and transmitting video data from the camera to the monitor.

When you are ready to intubate the patient, ensure that you also complete the procedure [Insert the Video Baton into the Stat](#) on page 17. It is recommended that you leave the single-use Stat in the packaging while inserting the video baton and that you do not remove the Stat from the packaging until you are ready to perform an intubation procedure. This helps ensure that the equipment remains as clean as possible.

1. Ensure that the power switch is in the OFF position.

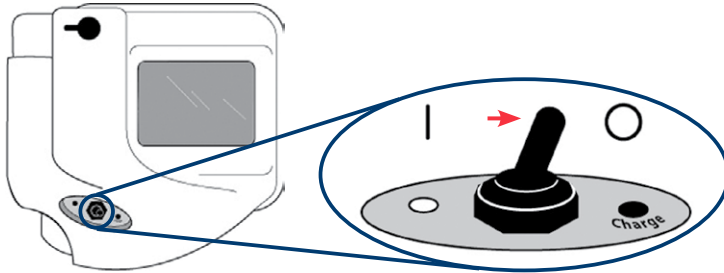

2. Align the dot on the video cable connector and the arrow on the video cable port.

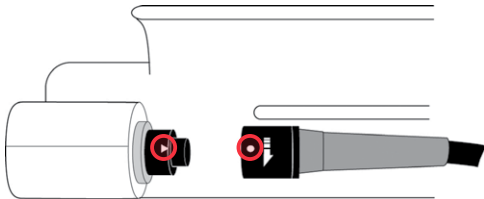

3. Insert the video cable connector into the port. You will hear a click when the cable is successfully connected.

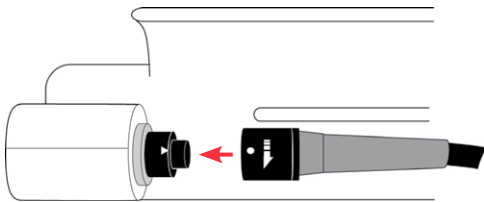

4. To disconnect the video cable from the monitor, rotate the connector ring in the direction of the release arrow, and then remove the connector from the port.

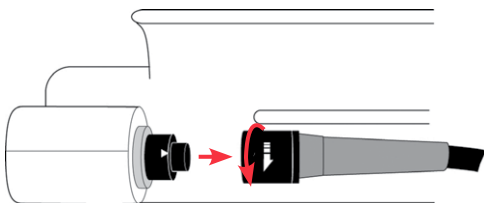

5. Continue to the procedure [Perform a Functional Check](#) on page 14.

---

## PROCEDURE 4. PERFORM A FUNCTIONAL CHECK

---

Before you use the device for the first time, perform the following functional check to ensure that the system is working properly. Please contact Customer Care if your system does not function as described below.

1. Ensure that you have fully charged the battery according to the instructions in [Charge the Monitor](#) on page 11.
2. Ensure that you have attached the video baton to the monitor, according to the instructions in [Connect a Video Baton](#) on page 13.
3. On the video monitor, turn the power switch to the ON position.

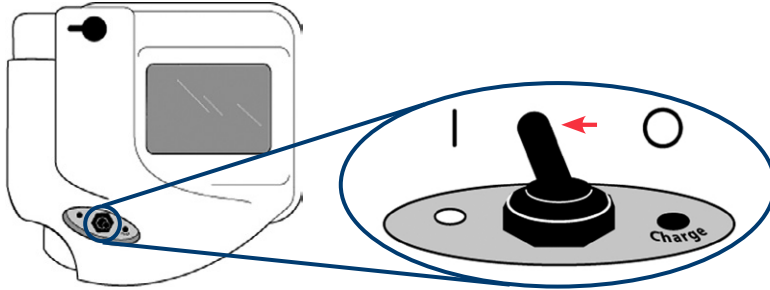

4. Look at the monitor screen, and verify that the image displayed is being received from the video baton.

# USING THE DEVICE

---

Prior to using the device, set up the device according to the instructions in the previous chapter, and verify the setup by completing the procedure [Perform a Functional Check](#).



## WARNING

GlideScope systems are delivered nonsterile and require cleaning or disinfection prior to initial use.



## WARNING

Before every use, ensure the instrument is operating correctly and has no sign of damage. Do not use this product if the device appears damaged. Always ensure that alternative airway management methods and equipment are readily available.

Report any suspected defects to Verathon® Customer Care. For contact information, visit [verathon.com/support](https://www.verathon.com/support).

Ranger video batons are equipped with the an anti-fog feature, which reduces camera fogging during the intubation procedure. To fully optimize the feature, you must allow the video laryngoscope to warm up for 30–120 seconds prior to use, depending on the ambient temperature and humidity of the clinical environment. Full optimization of the anti-fog feature is not necessary to use the device; if desired, you may begin the intubation procedure immediately.

*Note: If the video laryngoscope is stored in cold conditions, additional warming time may be required for optimal performance of the anti-fog feature.*

Using the system consists of the following procedures:

- [Procedure 1: Connect a Video Baton](#)
- [Procedure 2: Insert the Video Baton into the Stat](#)
- [Procedure 3: Prepare the System](#)
- [Procedure 4: Intubate Using the GlideScope 4-Step Technique](#)

## PROCEDURE 1. CONNECT A VIDEO BATON

Table 3. Video Laryngoscope Sizes

SIZES		
Stat	Video Baton	Recommended Patient Weight/Size*
GVL® 0 Stat	Video baton 1-2	Patients less than 1.5 kg (3.3 lbs)
GVL 1 Stat	Video baton 1-2	Patients between 1.5–3.8 kg (3.3–8.4 lbs)
GVL 2 Stat	Video baton 1-2	Patients between 1.8–10 kg (4–22 lbs)
GVL 2.5 Stat	Video baton 1-2	Patients between 10–28 kg (22–61.7 lbs)
GVL 3 Stat	Video baton 3-4	Patients between 10 kg–adult (22 lbs–adult)
GVL 4 Stat	Video baton 3-4	Patients between 40 kg–morbidly obese (88 lbs–morbidly obese)

\* Weight ranges are approximate; a medical professional must evaluate on a patient-by-patient basis.

1. Ensure that the battery is sufficiently charged. For more information, see [Charge the Monitor](#) on page 11.
2. Ensure the GlideScope system components have been properly cleaned and disinfected. For more information, see the [Cleaning & Disinfecting](#) chapter on page 20.
3. Using the information in [Table 3](#), in combination with a clinical assessment of the patient and the experience and judgment of the clinician, select the GlideScope video laryngoscope that is appropriate for the patient.
4. Ensure that the power switch is in the OFF position.

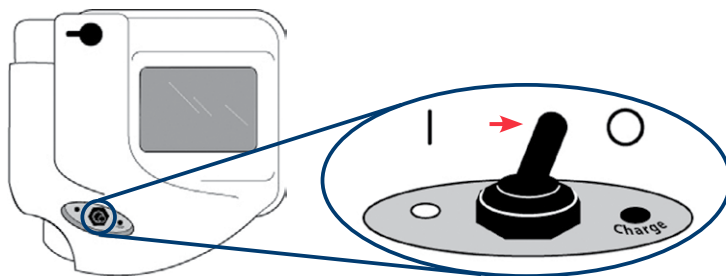

5. Align the dot on the video cable connector and the arrow on the video cable port.

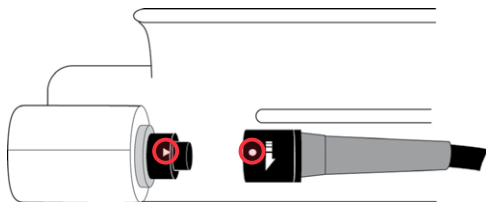

6. Insert the video cable connector into the port. You will hear a click when the cable is successfully connected.

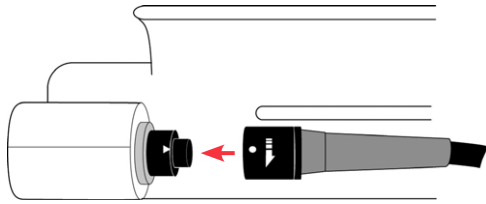

7. Continue to the procedure [Insert the Video Baton into the Stat](#).

---

## PROCEDURE 2. INSERT THE VIDEO BATON INTO THE STAT

---

1. Open the GVL® Stat pouch, but do not remove the Stat from the packaging.
2. Ensure that the logo on the side of the baton and the logo on the side of the Stat are aligned.
3. Slide the video baton into the GVL Stat until it clicks into place. Do not remove the Stat from the pouch until you are ready to begin the intubation. This ensures that the Stat remains as clean as possible.

*Note: Ensure that you do not insert the video baton backwards.*

Correct



Incorrect

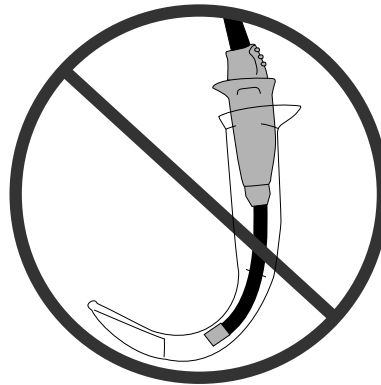

4. If needed, allow the anti-fog feature to warm up for 30–120 seconds.

*Note: The time required for the anti-fog feature to be fully optimized varies according to the ambient temperature and humidity where the equipment is being stored or used. If the video baton or Stat is stored in cold conditions, additional warming time may be required for optimal performance of the anti-fog feature.*

5. When you remove the GVL Stat from the packaging, visually inspect the Stat to ensure that all exterior surfaces are free of unintended rough areas, sharp edges, protrusions, or cracks.
6. Continue to the procedure [Prepare the System](#).

---

## PROCEDURE 3. PREPARE THE SYSTEM

---

1. On the video monitor, turn the power switch to the ON position.

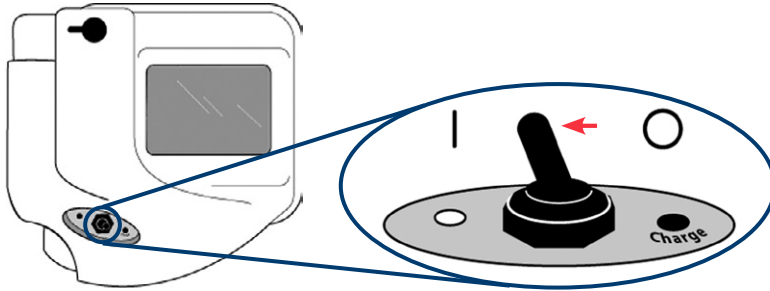

2. On the monitor screen, verify that the image displayed is from the video baton camera.
3. If needed, allow the anti-fog feature to warm up for 30–120 seconds, and then continue to the procedure [Intubate Using the GlideScope 4-Step Technique](#) on page 19.

*Note: The time required for the anti-fog feature to be fully optimized varies according to the ambient temperature and humidity where the equipment is being stored or used. If the video baton or Stat is stored in cold conditions, additional warming time may be required for optimal performance of the anti-fog feature.*



## PROCEDURE 4. INTUBATE USING THE GLIDESCOPE 4-STEP TECHNIQUE



### WARNING

When you are guiding the endotracheal tube to the distal tip of the video laryngoscope, ensure that you are looking in the patient's mouth, not at the video monitor screen. Failure to do so may result in injury to the tonsils or soft palate.



### WARNING

Several areas of the Stat that contact the patient can exceed 41°C (106°F) as part of normal operation:

- The first area is the light-emitting area surrounding the camera. When used as indicated, continuous contact with this area is unlikely because, if tissue were to contact this area, the view would be lost and devices would need to be adjusted to regain the airway view.
- The second area is the area surrounding the camera, out of view of the camera. Continuous contact with this area is unlikely because the product is typically not held stationary for an extended period of time exceeding 1 minute.

If continuous contact is maintained for longer than 1 minute, it is possible to cause thermal damage such as a burn to the mucosal tissue.

To perform an intubation, Verathon® recommends using the GlideScope 4-Step Technique as outlined in this procedure. Each step begins with where the user should be looking to complete that action. Prior to beginning this procedure, verify that the monitor is receiving an accurate image from the video laryngoscope.

1. **Look in the Mouth:** With the video laryngoscope in your left hand, introduce it into the midline of the oral pharynx.
2. **Look at the Screen:** Identify the epiglottis, and then manipulate the blade in order to obtain the best glottic view.

Figure 5. *Ideal Glottic View*



3. **Look in the Mouth:** Carefully guide the distal tip of the tube into position near the tip of the laryngoscope.
4. **Look at the Screen:** Complete the intubation, gently rotating or angling the tube as needed to redirect it.

# CLEANING & DISINFECTING

---

## GENERAL INFORMATION



### WARNING

GlideScope systems are delivered nonsterile and require cleaning or disinfection prior to initial use.



### WARNING

Because the product may be contaminated with human blood or body fluids capable of transmitting pathogens, all cleaning facilities must be in compliance with (U.S.) OSHA Standard 29 CFR 1910.1030 "Bloodborne Pathogens" or an equivalent standard. For more information, visit [www.osha.gov](http://www.osha.gov).



### WARNING

This product may only be cleaned, disinfected, or sterilized by using the approved low-temperature processes provided in this manual. Cleaning, disinfection, and sterilization methods listed are recommended by Verathon® based on efficacy or compatibility with component materials.



### WARNING

Availability of cleaning and disinfection products varies by country, and Verathon is unable to test products in every market. For more information, please contact Verathon Customer Care. For contact information, visit [verathon.com/support](http://verathon.com/support).



### WARNING

Cleaning is critical to ensuring a component is ready for disinfection or sterilization. Failure to properly clean the device could result in a contaminated instrument after completing the disinfection or sterilization procedure.

When cleaning, ensure all foreign matter is removed from the surface of the device. This allows the active ingredients of the chosen disinfection method to reach all the surfaces.

Cleaning and disinfecting the GlideScope Ranger system is an important part of using and maintaining the system. Prior to each use, ensure that each system component has been cleaned and disinfected according to the guidance provided in [Table 4](#).

The following table describes the risk assessment for each system component, including the Spaulding's/CDC classification for the minimum required disinfection level.

*Table 4. GlideScope Ranger System Risk Assessment*

DEVICE	PACKAGED	USE	SPAULDING'S/CDC CLASSIFICATION	DISINFECTION LEVEL		STERILIZE
				Low	High	
GlideRite® Rigid Stylet <sup>§</sup>	Nonsterile	Reusable	Semi-critical		X	
Video baton*	Nonsterile	Reusable	Noncritical	X		
Video monitor <sup>†</sup>	Nonsterile	Reusable	Noncritical			
Single-use Stat <sup>‡</sup>	Sterile	Single-Use	Semi-critical			
Cradle <sup>†</sup>	Nonsterile	Reusable	Noncritical			
Storage case <sup>†</sup>	Nonsterile	Reusable	Noncritical			

X Checked boxes show minimum disinfection level requirement.

■ Shaded areas indicate that the disinfection or sterilization level is not required or not compatible with the device materials.

□ Unshaded areas show permissible levels of disinfection or sterilization based on compatibility with the device materials.

\* When used as intended, the video baton is a nonsterile, reusable device that is protected from contact with mucous membranes and nonintact skin by the sterile, single-use Stat. Low-level disinfection is required for the video baton after every patient use. High-level disinfection is required for the video baton when it is visibly soiled.

† Clean these components when visibly soiled and on a regular basis, as per a schedule established by the medical care facility or provider.

‡ Single-use Stats may not be cleaned, disinfected, or sterilized. Dispose of single-use Stats after use.

§ For instructions on cleaning and disinfection, see the *GlideRite Rigid Stylet Operations and Maintenance Manual*.

After reviewing [Table 4](#), complete the following procedures to clean, disinfect, or sterilize the system components:

- **General Information**
  - Procedure 1: Clean the Video Monitor
  - Procedure 2: Clean the Video Baton Cradle
  - Procedure 3: Clean the Storage Case
- **Video Baton**
  - Procedure 1: Remove the Stat
  - Procedure 2: Clean & Disinfect the Video Baton
  - Procedure 3: Inspect the Video Baton

---

## **PROCEDURE 1. CLEAN THE VIDEO MONITOR**

---

### **IMPORTANT**

Ensure that you do not use any abrasive substances, brushes, pads, or tools when cleaning the video monitor screen. The screen can be scratched, permanently damaging the device.

Clean the video monitor when it is visibly soiled and on a regular basis, as per a schedule established by the medical care facility or provider.

1. Turn off the Ranger video monitor, and then unplug the system from direct power.
2. Using 70% isopropyl alcohol (IPA), 100 ppm bleach solution, or a mild detergent with water, wipe the exterior of the video monitor.

---

## **PROCEDURE 2. CLEAN THE VIDEO BATON CRADLE**

---

1. Using a standard, hospital-grade surface-cleaning product, wipe the cradle.

---

## **PROCEDURE 3. CLEAN THE STORAGE CASE**

---

1. Using 70% IPA, 100 ppm bleach solution, or a mild detergent and water, wipe the exterior of the case.

## VIDEO BATON

For more information about the risk assessment of Ranger system components, see [Table 4](#) on page 21.

---

### PROCEDURE 1. REMOVE THE STAT

---

The GVL® Stat is a sterile, single-use device. After each use, it is a biohazard, and it should be removed from the video baton and disposed of in a manner consistent with local protocols.

1. Hold the Stat in one hand.
2. To reduce the force required to remove the video baton from the Stat, use your thumb and finger to gently press the collar of the Stat.
3. With the other hand, grasp the handle of the video baton and pull firmly.

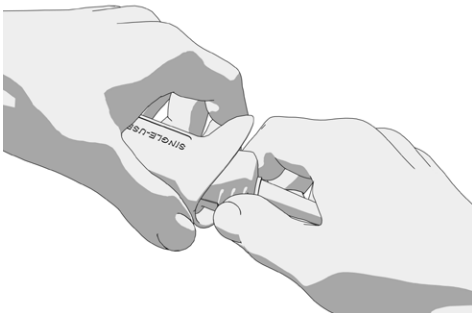

## PROCEDURE 2. CLEAN & DISINFECT THE VIDEO BATON

When used as intended, the video baton is a nonsterile, reusable device that is protected from contact with mucous membranes and non-intact skin by the Stat (sterile, single-use). Low-level disinfection is recommended for the video baton after every patient use. High-level disinfection is required when it is visibly soiled.

### IMPORTANT

Do not use metal or abrasive brushes, scrub pads, or rigid tools to clean the video baton. The window that protects the camera and light can be scratched, permanently damaging the device.

This product is heat-sensitive, and exposing the components to temperatures in excess of 60°C (140°F) will cause damage to the electronics and void the device warranty.

Table 5. Cleaning & Disinfection Methods for the GlideScope Ranger Video Baton

CHEMICAL	MAXIMUM CONCENTRATION	DISINFECTION LEVEL
Enzymatic debridement agent or detergent	—	Cleaner
Bleach*	500 ppm	Low
Isopropyl alcohol solution	70%	Low
Hydrogen peroxide	≤ 7.5%	High
Glutaraldehyde	≤ 3.4%	High
Ortho-phthalaldehyde	0.55%	High
Peracetic acid	0.2%	High/Sterilization
Vaporized hydrogen peroxide <sup>†</sup>	90%	Sterilization

\* Bleach may be used on the video batons, but pay special attention to stainless steel components, as bleach can corrode stainless steel.

† GlideScope Ranger video batons designed to withstand vaporized hydrogen peroxide are identified by a metal label. If the component does not feature a metal label, do not use this solution.

### CLEAN THE VIDEO BATON

1. Ensure the video monitor has been turned off.
2. Disconnect the video cable from the monitor by rotating the connector ring in the direction of the release arrow, and then removing the connector from the port.

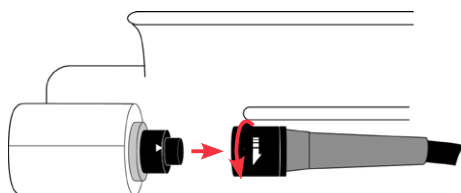

3. Place the protective cleaning cap over the connector.

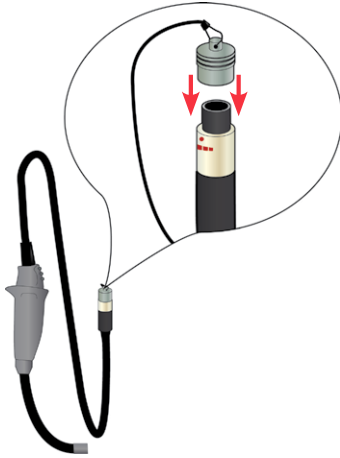

4. Wash the component manually using a hospital-grade equipment detergent or an enzymatic debridement agent, according to the chemical manufacturer's instructions.
5. Using warm water, rinse the component in clean tap water and scrub with a soft-bristled brush until all visible contamination has been removed.  
To prevent damage, use a cotton swab in order to clean around the camera window.
6. Ensure all foreign material (e.g., soil and organic material) is removed from the surface of the device. It is critical to remove all traces of contamination from the component prior to completing disinfection or sterilization procedures.
7. Using a clean, lint-free cloth, hospital-grade clean air, or a low-temperature dryer, dry the component.

The component may now be disinfected or sterilized.

#### **DISINFECT OR STERILIZE THE VIDEO BATON**

8. Ensure the equipment is clean according to the previous steps.
9. Ensure the protective cap on the connector is secure.
10. Prepare and condition the disinfection or sterilization solution according to the solution manufacturer's instructions and the maximum concentration stated in [Table 5](#).
11. Disinfect or sterilize the video baton according to the solution manufacturer's instructions. The exposure process and times vary depending on the solution.
12. If applicable, rinse the component according to the solution manufacturer's instructions.
13. Dry the component by using a sterile cloth, hospital-grade clean air, or a low-temperature dryer.
14. Inspect the video baton according to the instructions in the following procedure, and then store the component in a clean environment.

---

## PROCEDURE 3. INSPECT THE VIDEO BATON

---



### WARNING

Before every use, ensure the instrument is operating correctly and has no sign of damage. Do not use this product if the device appears damaged. Always ensure that alternative airway management methods and equipment are readily available.

Report any suspected defects to Verathon® Customer Care. For contact information, visit [verathon.com/support](https://www.verathon.com/support).

1. Visually inspect the video baton for signs of damage. Perform a routine inspection of the video baton before and after every use to ensure that all endoscopic components are free of unintended rough surfaces, sharp edges, protrusions, or cracks.





# MAINTENANCE & SAFETY

---

## PERIODIC INSPECTIONS

Periodic inspections should be performed to ensure safe and effective operation, in addition to performing routine inspection by the user before and after every use. It is recommended that an operator familiar with the instrument perform a full visual inspection of all components at least every three months. The inspector should check the system for the following:

- External damage to the equipment
- Damage to the power supply or adapter
- Damage to the connectors or cable insulation

Report any suspected defects to Verathon® Customer Care. For contact information, see [verathon.com/support](https://verathon.com/support).

## SYSTEM SOFTWARE

This manual documents the most current version of the software. If your system does not function as described in this manual, or to determine if your software should be updated, contact Verathon Customer Care.

Do not perform any software upgrades from third-party vendors or attempt to modify the existing software. Doing so may damage the monitor and/or void the warranty.

## GLIDESCOPE RANGER BATTERY

For battery specifications, see the [Battery Specifications](#) section on page 32.

The battery is not user-replaceable. In case of battery malfunction, do not attempt to replace the monitor battery. Any attempts to replace the battery by unauthorized service technicians may cause serious harm to the user and will void the warranty. Please contact your Verathon Customer Care representative for more information on battery replacement.

## DEVICE REPAIR

The GlideScope Ranger system components are not user-serviceable. Verathon® does not make available any type of circuit diagrams, component parts lists, descriptions, or other information that would be required for repairing the device and related accessories. All service must be performed by a qualified technician.

If you have any questions, contact your local Verathon representative or Verathon Customer Care.



### WARNING

No modification of this equipment is allowed.



### WARNING

**Electric shock hazard.** Do not attempt to open the system components. This may cause serious injury to the operator or damage to the instrument and will void the warranty. Contact Verathon Customer Care for all servicing needs.



### CAUTION

The GlideScope Ranger video monitor is manufactured to be IP68 compliant. If the monitor is disassembled during a service procedure, after reassembly, the monitor will not be IP68 compliant.

## DEVICE DISPOSAL

The GlideScope Ranger instrument and related devices may contain batteries and other environmentally hazardous materials. When the instrument has reached the end of its useful service life, it must be disposed of in accordance with WEEE requirements. Coordinate disposal through your Verathon Service Center, or alternatively, follow your local protocols for hazardous waste disposal.

# WARRANTY

---

## ORIGINAL FIRST YEAR TOTAL CUSTOMER CARE WARRANTY

Verathon® warrants the system against defects in material and workmanship. The limited warranty applies for one (1) year from the date of shipment from Verathon and applies only to the original purchaser of the system. The terms of this warranty are subject to the *Terms and Conditions of Sale* or any other contractual document between the parties.

Verathon's policy is to honor product warranties and to perform services only on products purchased from an authorized Verathon dealer. If you purchase a Verathon product or system components from an unauthorized dealer or if the original factory serial number has been removed, defaced or altered, your Verathon warranty will be void. Purchasing Verathon products from unauthorized entities could result in receipt of product that is counterfeit, stolen, used, defective, or not intended for use in your region.

If a customer's system requires service or repair, Verathon will, at its discretion, either repair or replace the customer's unit and provide a loaner unit. The customer agrees to send the defective unit to Verathon (cleaned and disinfected as appropriate) upon receipt of the loaner unit, and the customer agrees to return the loaner unit within two (2) business days of receipt of the repaired unit. All exchanged parts become property of Verathon.

Each product manufactured by Verathon is warranted to be free from defects in material and workmanship under normal use and services. Verathon's warranty does not cover defects or problems caused by the buyer's acts (or failure to act), the acts of others, or events beyond Verathon's reasonable control. The buyer shall be solely responsible, for any problem, failure, malfunction, defect, claim, damage, liability, or safety issue arising out of the following:

- Accident, theft, misuse, abuse, extraordinary wear and tear, or neglect.
- Misapplication, improper use, or other failure to follow Verathon's product instructions and safety precautions. The system shall be used in accordance with the instructions contained in this manual. This warranty does not apply if there is evidence of the equipment being exposed to temperatures in excess of 60°C (140°F).
- Use of the system in conjunction with hardware, software, components, services, accessories, attachments, interfaces, or consumables, other than those supplied or specified by Verathon.
- Products that have been repaired or maintained by anyone other than a Verathon authorized service provider. Modification, disassembly, rewiring, re-engineering, recalibration, and/or reprogramming of products other than as specifically authorized by Verathon in writing is prohibited and will void all warranties.

This warranty provides coverage if the instrument is rendered inoperable as a result of an accidental drop or mishandling after payment by the buyer of the current deductible as determined by Verathon. The deductible charge will be applied on each warranty request and may be applied an unlimited number of times per instrument.

## WHAT IS COVERED?

Warranty coverage applies to the following system components:

- GlideScope Ranger video monitor
- GlideScope Ranger video baton

Additional reusable components purchased either singularly or as a part of a system are warranted separately. Consumable items are not covered under this warranty.

## PREMIUM CUSTOMER CARE WARRANTY

You may purchase a Premium Customer Care<sup>SM</sup> warranty that extends the limited warranty. For more information, contact Verathon<sup>®</sup> Customer Care or your local representative.

## DISCLAIMER OF ADDITIONAL WARRANTIES

There are no understandings, agreements, representations of warranties expressed or implied (including warranties of merchantability or fitness for a particular purpose) other than those set forth in this chapter and the *Terms and Conditions of Sale*. The contents of this manual do not constitute a warranty.

Some states disallow certain limitations on applied warranties. The purchaser should consult state law if there is a question regarding this disclaimer. The information, descriptions, recommendations, and safety notations in this manual are based upon Verathon experience and judgment. The contents of this manual should not be considered to be all-inclusive or to cover all contingencies.

# PRODUCT SPECIFICATIONS

---

## SYSTEM SPECIFICATIONS

GENERAL SPECIFICATIONS	
Classification:	Electrical Class II, Applied Part BF
Line voltage:	100–240 VAC, 50 and 60 Hz
DC power supply:	Max 0.25 A
Ingress protection:	IP68, up to 1 m (3 ft) for 60 minutes
OPERATING & STORAGE SPECIFICATIONS	
Operating Specifications	
Temperature:	10 to 40°C (50 to 104°F)
Relative humidity:	0–95%
Atmospheric pressure:	440–1060 hPa
Shipping and Storage Conditions	
Temperature:	-20 to 45°C (-4 to 113°F)
Relative humidity:	0–95%
Atmospheric pressure:	440–1060 hPa

# COMPONENT SPECIFICATIONS

## VIDEO MONITOR

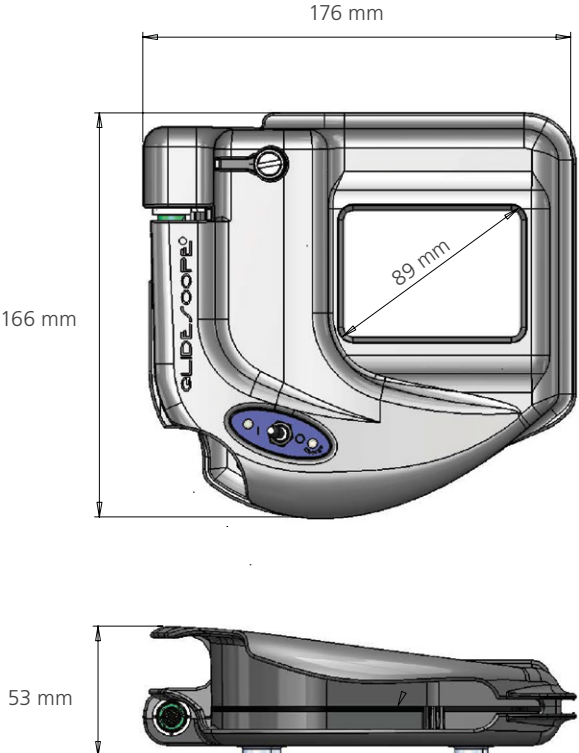

SPECIFICATIONS	COMPONENT
<b>Ranger Video Monitor</b>	
<p>LCD TFT, 320 x 240 px</p> <p>Monitor: 89 mm (3.5 in)</p> <p>Height: 166 mm</p> <p>Width: 176 mm</p> <p>Depth: 53 mm</p> <p>Weight: 570 g</p>	 <p>The image shows two views of the Ranger Video Monitor. The top view is a perspective drawing showing the device's width (176 mm) and height (166 mm). A diagonal line indicates the monitor size is 89 mm. The bottom view is a side profile showing the device's depth (53 mm). The device is grey with a blue lens and has 'GLIDESCOPE' printed on the side.</p>

## BATTERY SPECIFICATIONS

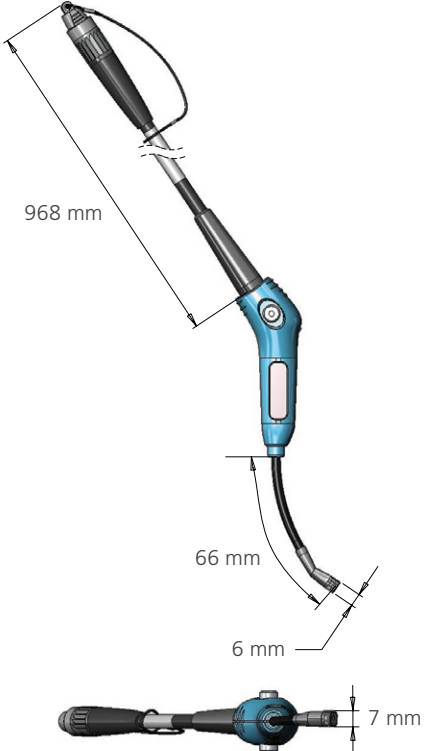
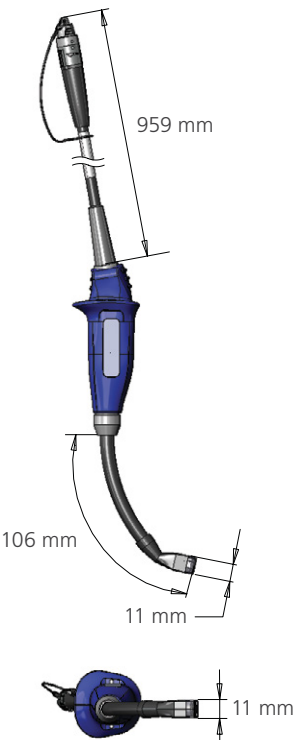

CONDITION	SPECIFICATION
Battery type	Lithium
Battery life	Under normal operating conditions, a fully charged battery lasts approximately 90 minutes.
Charging time	Charging time takes no more than 5 hours from an empty battery to a full charge.
Rated capacity	1150–1300 mAh
Nominal voltage	11.1 V
Max charging voltage	12.0-13.2 V

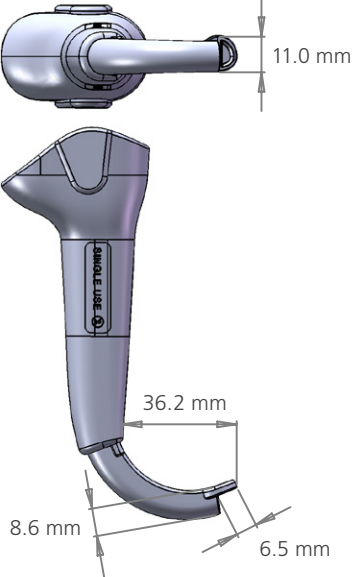

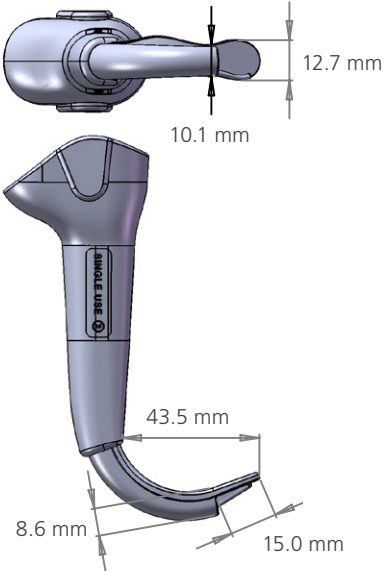
## VIDEO BATONS & STATS

SPECIFICATIONS	COMPONENT
<b>Ranger Video Baton 1-2</b>	
<p>Cable length: 968 mm</p> <p>Length of flexible baton: 66 mm</p> <p>Height at camera: 6 mm</p> <p>Width at camera: 7 mm</p>	 <p>The diagram shows a blue and black video baton. A dimension line indicates the total cable length is 968 mm. A curved dimension line shows the length of the flexible baton is 66 mm. A vertical dimension line shows the camera height is 6 mm. A horizontal dimension line shows the camera width is 7 mm. A side view of the camera head is also shown below the main view.</p>
<b>Ranger Video Baton 3-4</b>	
<p>Cable length: 959 mm</p> <p>Length of flexible baton: 106 mm</p> <p>Height at camera: 11 mm</p> <p>Width at camera: 11 mm</p>	 <p>The diagram shows a blue and black video baton. A dimension line indicates the total cable length is 959 mm. A curved dimension line shows the length of the flexible baton is 106 mm. A vertical dimension line shows the camera height is 11 mm. A horizontal dimension line shows the camera width is 11 mm. A side view of the camera head is also shown below the main view.</p>

SPECIFICATIONS	COMPONENT
<b>GVL 0 Stat</b>	
<p>Blade tip to handle: 36.2 mm</p> <p>Height at camera: 8.6 mm</p> <p>Width at camera: 11.0 mm</p> <p>Blade length in front of camera: 6.5 mm</p> <p>Max blade width in front of camera: 11.0 mm</p> 	
<b>GVL 1 Stat</b>	
<p>Blade tip to handle: 43.5 mm</p> <p>Height at camera: 8.6 mm</p> <p>Width at camera: 10.1 mm</p> <p>Blade length in front of camera: 15.0 mm</p> <p>Max blade width in front of camera: 12.7 mm</p> 	

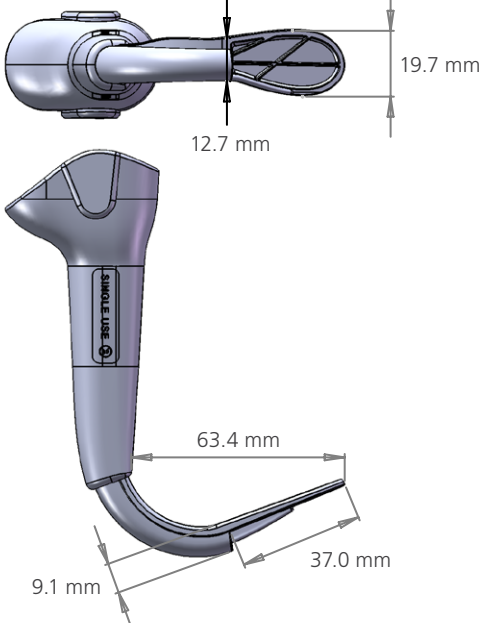

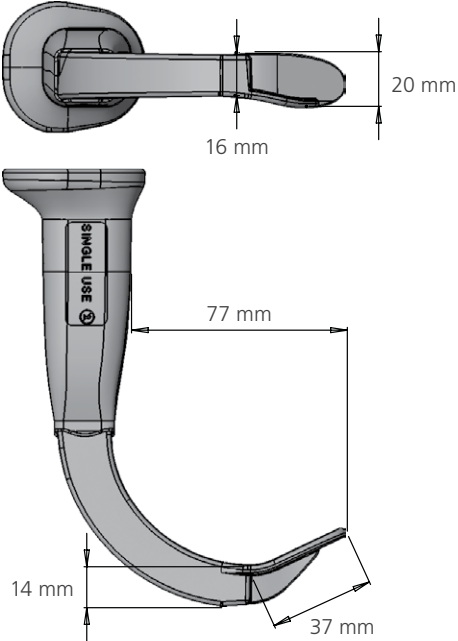
SPECIFICATIONS	COMPONENT
<b>GVL 2 Stat</b>	
<p>Blade tip to handle: 55.7 mm</p> <p>Height at camera: 8.6 mm</p> <p>Width at camera: 11.2 mm</p> <p>Blade length in front of camera: 28.0 mm</p> <p>Max blade width in front of camera: 16.0 mm</p> 	
<b>GVL 2.5 Stat</b>	
<p>Blade tip to handle: 63.4 mm</p> <p>Height at camera: 9.1 mm</p> <p>Width at camera: 12.7 mm</p> <p>Blade length in front of camera: 37.0 mm</p> <p>Max blade width in front of camera: 19.7 mm</p> 	

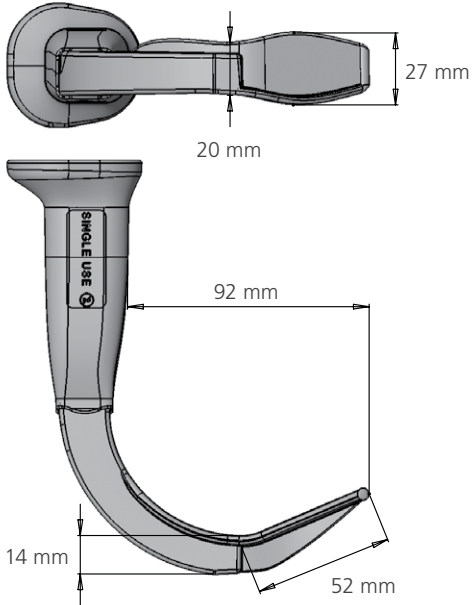
SPECIFICATIONS	COMPONENT
<b>GVL 3 Stat</b>	
<p>Blade tip to handle: 77 mm</p> <p>Height at camera: 14 mm</p> <p>Width at camera: 16 mm</p> <p>Blade length in front of camera: 37 mm</p> <p>Max blade width in front of camera: 20 mm</p> 	
<b>GVL 4 Stat</b>	
<p>Blade tip to handle: 92 mm</p> <p>Height at camera: 14 mm</p> <p>Width at camera: 20 mm</p> <p>Blade length in front of camera: 52 mm</p> <p>Max blade width in front of camera: 27 mm</p> 	

## ELECTROMAGNETIC COMPATIBILITY

GlideScope Ranger system is designed to be in compliance with IEC 60601-1-2:2007, which contains electromagnetic compatibility (EMC) requirements for medical electrical equipment. The limits for emissions and immunity specified in this standard are designed to provide reasonable protection against harmful interference in a typical medical installation.

The GlideScope Ranger system complies with the applicable essential performance requirements specified in IEC 60601-1 and IEC 60601-2-18. Results of immunity testing show that the essential performance of the system is not affected under the test conditions described in the following tables. For more information about the essential performance of the GlideScope Ranger system, see [Essential Performance](#) on page 1.

## ELECTROMAGNETIC EMISSIONS

Table 6. *Guidance and Manufacturer’s Declaration—Electromagnetic Emissions*

The GlideScope Ranger system is intended for use in the electromagnetic environment specified below. The customer or the user of the GlideScope Ranger system should assure that it is used in such an environment.

EMISSIONS TEST	COMPLIANCE	ELECTROMAGNETIC ENVIRONMENT – GUIDANCE
RF emissions CISPR 11	Group 1	The GlideScope Ranger system uses RF energy only for its internal function. Therefore, its RF emissions are very low and are not likely to cause any interference in nearby electronic equipment.
RF emissions CISPR 11	Class A	The GlideScope Ranger system is suitable for use in all establishments other than domestic and those directly connected to the public low-voltage power supply network that supplies buildings used for domestic purposes.
Harmonic emissions IEC 61000-3-2	Class A	
Voltage fluctuations/ flicker emissions IEC 61000-3-3	Complies	

## ELECTROMAGNETIC IMMUNITY

Table 7. Guidance and Manufacturer’s Declaration—Electromagnetic Immunity

The GlideScope Ranger system is intended for use in the electromagnetic environment specified below. The customer or the user of the GlideScope Ranger system should assure that it is used in such an environment.

IMMUNITY TESTS	IEC 60601 TEST LEVEL	COMPLIANCE LEVEL	ELECTROMAGNETIC ENVIRONMENT – GUIDANCE
Electrostatic discharge (ESD) IEC 61000-4-2	± 6 kV contact ± 8 kV air	In compliance	Floors should be wood, concrete, or ceramic tile. If floors are covered with synthetic material, the relative humidity should be at least 30%.
Electrical fast transient/burst IEC 61000-4-4	± 2 kV for power supply lines ± 1 kV for input/output lines	In compliance	Mains power quality should be that of a typical commercial or hospital environment.
Surge IEC 61000-4-5	± 1 kV line(s) to line(s) ± 2 kV line(s) to earth	In compliance	Mains power quality should be that of a typical commercial or hospital environment.
Voltage dips, short interruptions and voltage variations on power supply input lines IEC 61000-4-11	<5% $U_T$ (>95% dip in $U_T$ ) for 0.5 cycle 40% $U_T$ (60% dip in $U_T$ ) for 5 cycles 70% $U_T$ (30% dip in $U_T$ ) for 25 cycles <5% $U_T$ (>95% dip in $U_T$ ) for 5 s	In compliance	Mains power quality should be that of a typical commercial or hospital environment. If the user of the GlideScope Ranger system requires continued operation during power mains interruptions, it is recommended that the GlideScope Ranger system be powered from an uninterruptible power supply or a battery.
Power frequency (50/60 Hz) magnetic field IEC 61000-4-8	3 A/m	In compliance	Power frequency magnetic fields should be at levels characteristic of a typical location in a typical commercial or hospital environment.
Conducted RF IEC 61000-4-6	3 V <sub>rms</sub> 150 kHz to 80 MHz	3 V	Portable and mobile RF communications equipment should be used no closer to any part of the GlideScope Ranger system, including cables, than the recommended separation distance calculated from the equation applicable to the frequency of the transmitter.  <b>Recommended separation distance d (m)</b> $d=1.2 \sqrt{P}$

Table 7. Guidance and Manufacturer’s Declaration—Electromagnetic Immunity

The GlideScope Ranger system is intended for use in the electromagnetic environment specified below. The customer or the user of the GlideScope Ranger system should assure that it is used in such an environment.

IMMUNITY TESTS	IEC 60601 TEST LEVEL	COMPLIANCE LEVEL	ELECTROMAGNETIC ENVIRONMENT – GUIDANCE
Radiated RF IEC 61000-4-3	3 V/m 80 MHz to 2.5 GHz	3 V/m	$d=1.2 \sqrt{P}$ 80 MHz to 800 MHz $d=2.3 \sqrt{P}$ 800 MHz to 2.5 GHz where $P$ is the maximum output power rating of the transmitter in watts (W) according to the transmitter manufacturer and $d$ is the recommended separation distance in meters (m). Field strengths from fixed RF transmitters, as determined by an electromagnetic site survey, <sup>a</sup> should be less than the compliance level in each frequency range. <sup>b</sup> Interference may occur in the vicinity of equipment marked with the following symbol: 

Note:  $U_T$  is the AC mains voltage prior to application of the test level.

At 80 MHz and 800 MHz, the higher frequency range applies.

These guidelines may not apply in all situations. Electromagnetic propagation is affected by absorption and reflection from structures, objects and people.

- a. Field strengths from fixed transmitters, such as base stations for radio (cellular/cordless) telephones and land mobile radios, amateur radio, AM and FM radio broadcast and TV broadcast cannot be predicted theoretically with accuracy. To assess the electromagnetic environment due to fixed RF transmitters, an electromagnetic site survey should be considered. If the measured field strength in the location in which the GlideScope Ranger system is used exceeds the applicable RF compliance level above, the GlideScope Ranger system should be observed to verify normal operation. If abnormal performance is observed, additional measures may be necessary, such as re-orienting or relocating the GlideScope Ranger system.
- b. Over the frequency range 150 kHz to 80 MHz, field strengths should be less than 3 V/m.

## RECOMMENDED SEPARATION DISTANCES

Table 8. Recommended Separation Distances between Portable and Mobile RF Communications Equipment and the GlideScope Ranger System

The GlideScope Ranger system is intended for use in an electromagnetic environment in which radiated RF disturbances are controlled. The customer or the user of the GlideScope Ranger system can help prevent electromagnetic interference by maintaining a minimum distance between portable and mobile RF communications equipment (transmitters) and the GlideScope Ranger system as recommended below, according to the maximum output power of the communications equipment.

RATED MAXIMUM OUTPUT POWER OF TRANSMITTER (W)	SEPARATION DISTANCE ACCORDING TO FREQUENCY OF TRANSMITTER (m)		
	150 kHz to 80 MHz $d=1.2 \sqrt{P}$	80 MHz to 800 MHz $d=1.2 \sqrt{P}$	800 MHz to 2.5 GHz $d=2.3 \sqrt{P}$
0.01	0.12	0.12	0.23
0.1	0.38	0.38	0.73
1	1.2	1.2	2.3
10	3.8	3.8	7.3
100	12	12	23

For transmitters rated at a maximum output power not listed above, the recommended separation distance  $d$  in meters (m) can be estimated using the equation applicable to the frequency of the transmitter, where  $P$  is the maximum output power rating of the transmitter in watts (W) according to the transmitter manufacturer.

Note: At 80 MHz and 800 MHz, the separation distance for the higher frequency range applies.

These guidelines may not apply in all situations. Electromagnetic propagation is affected by absorption and reflection from structures, objects and people.















## ACCESSORY CONFORMANCE TO STANDARDS















To maintain electromagnetic interference (EMI) within certified limits, the system must be used with the cables, components, and accessories specified or supplied by Verathon®. For additional information, see the [System Parts & Accessories](#) and [Component Specifications](#) sections. The use of accessories or cables other than those specified or supplied may result in increased emissions or decreased immunity of the system.

Table 9. EMC Standards for Accessories

ACCESSORY	MAX LENGTH
AC power cord	0.6 m (3 ft)
Medical power supply	—

# SYMBOL DIRECTORY

SYMBOL	MEANING
<b>Warnings &amp; Cautions</b>	
	Warning or Caution—Consult accompanying documents. Read instructions before connecting or operating.
	Non-ionizing, electromagnetic radiation
<b>Product Use &amp; Specifications</b>	
	Refer to the operations & maintenance manual
	Refer to the operations & maintenance manual
	Manufacturer
	Use-by date
	Catalog number
	Serial number
	Batch code
	Temperature limitation
	Humidity limitation
	Atmospheric pressure limitation
	Sterilized through irradiation
	Reuse is not allowed
	Statement of prescription

SYMBOL	MEANING
<b>Electrical &amp; Power</b>	
	Class II equipment
	Type BF applied part
	Energy Efficiency Level V
	Direct current
	Alternating current
	Connector polarity mark—positive
<b>Shipping &amp; Disposal</b>	
	Do not use if package is damaged
	Quantity per box
<b>Standards &amp; Certifications</b>	
	CE—Marked in accordance with the Medical Device Directive (MDD)
	CSA—Canadian Standards Association mark of certification to applicable standards for electromedical equipment
	EC REP—Authorized Representative in the European Community
	FCC—Tested to Federal Communications Commission requirements
	UL—Underwriters Laboratories Recognized Component certification mark
	TUV—Safety approval mark for components or subassemblies
	WEEE—Subject to waste electrical and electronic equipment regulations



# GLOSSARY

TERM	DEFINITION
A	Ampere
AC	Alternating current
C	Celsius
CFR	Code of Federal Regulations (U.S.)
CISPR	International Special Committee on Radio Interference
cm	Centimeter
CSA	Canadian Standards Association
EMI	Electromagnetic interference
ESD	Electrostatic discharge
Essential performance	The system performance necessary to achieve freedom from unacceptable risk
F	Fahrenheit
FCC	Federal Communications Commission (federal agency in U.S.)
ft	Foot
GHz	Gigahertz
hPa	Hectopascal
Hz	Hertz
IEC	International Electrotechnical Commission
in	Inch
IPA	Isopropyl alcohol
kHz	Kilohertz
kV	Kilovolt
m	Meter
mAh	Milliampere-hour
MDD	Medical Device Directive
MHz	Megahertz
mm	Millimeter
OSHA	Occupational Safety and Health Administration (federal agency in U.S.)
Pure water	Water that is suitable for high-level disinfection according to local regulations and your medical facility
RF	Radio frequency
UL	Underwriters Laboratories
V	Volt
Vrms	Voltage root mean squared
W	Watt
WEEE	Waste electrical and electronic equipment





